

### FEATURES

- Compatible with LT1181A and MAX232A
- High data rate - 250 kbits/sec under load
- 16-pin DIP or SOIC package
- 20-pin TSSOP package for height restricted applications
- Operate from single +5V power
- Meets all EIA-232E and V0.28 specifications
- Uses small capacitors: 0.1  $\mu$ F
- Optional industrial temperature range available (-40°C to +85°C)

### ORDERING INFORMATION

DS232A	16-pin DIP
DS232A-N	16-pin DIP (Industrial)
DS232AR	16-pin SOIC (150-Mil)
DS232AR-N	16-pin SOIC (150-Mil) (Industrial)
DS232AS	16-pin SOIC (300-Mil)
DS232AS-N	16-pin SOIC (300-Mil) (Industrial)
DS232AE	20-pin TSSOP
DS232AE-N	20-pin TSSOP (Industrial)

### PIN ASSIGNMENT

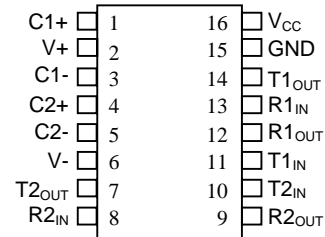

16-Pin DIP AND SOIC

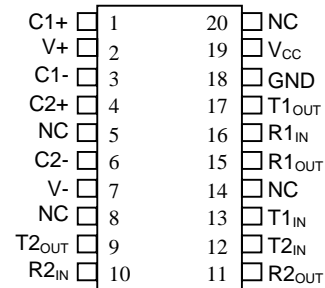

20-Pin TSSOP

### PIN DESCRIPTION

V <sub>CC</sub>	- +5-Volt Supply
GND	- Ground
V+	- Positive Supply Output
V-	- Negative Supply Output
T1 <sub>IN</sub> , T2 <sub>IN</sub>	- RS-232 Driver Inputs
T1 <sub>OUT</sub> , T2 <sub>OUT</sub>	- RS-232 Driver Outputs
R1 <sub>IN</sub> , R2 <sub>IN</sub>	- Receiver Inputs
R1 <sub>OUT</sub> , R2 <sub>OUT</sub>	- Receiver Outputs
C1+, C1-	- Capacitor 1 Connections
C2+, C2-	- Capacitor 2 Connections

### DESCRIPTION

The DS232A is a dual RS-232 driver/receiver pair that generates RS-232 voltage levels from a single +5-volt power supply. Additional  $\pm 12$ -volt supplies are not needed since the DS232A uses on-board charge pumps to convert the +5-volt supply to  $\pm 10$  volts. The DS232A is fully compliant with EIA RS-232E and V0.28/V0.24 standards. The DS232A contains two drivers and two receivers. Driver slew rates and data rates are guaranteed up to 250k bits/sec. The DS232A operates with only 0.1  $\mu$ F charge pump capacitors.

### OPERATION

The diagram in Figure 1 shows the main elements of the DS232A. The following paragraphs describe the function of each pin.

## FUNCTIONAL DIAGRAM OF DS232A Figure 1

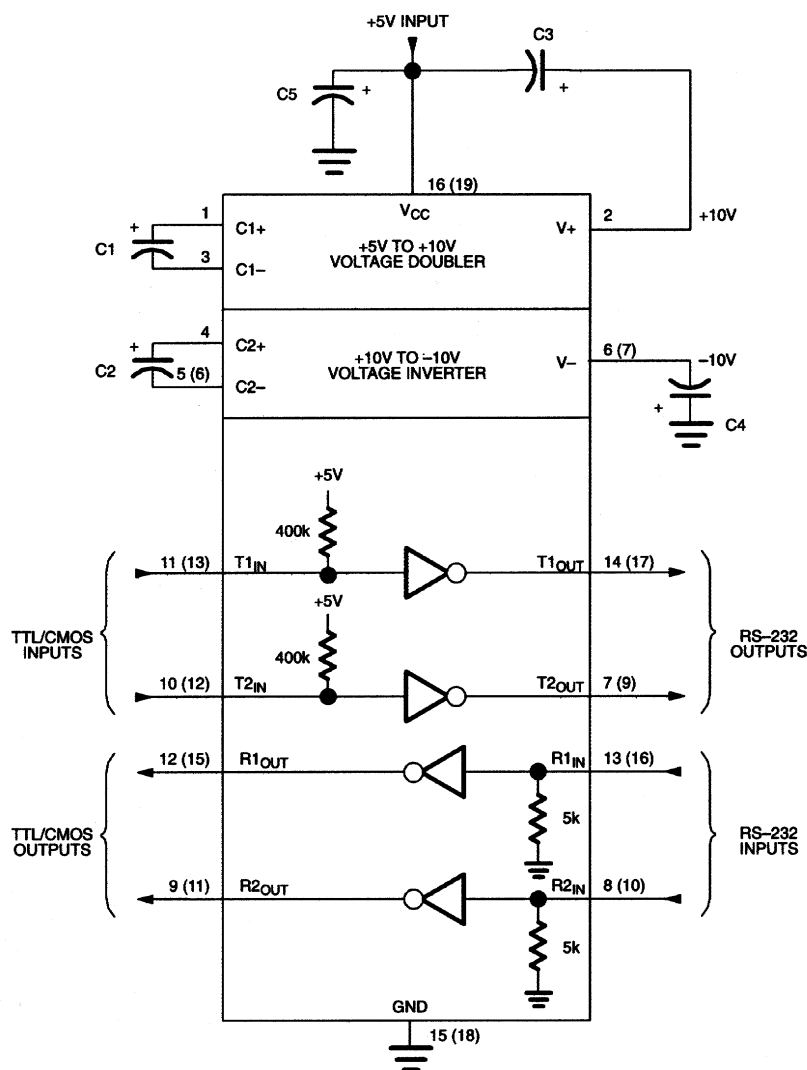

NOTE: C5 is a recommended decoupling capacitor which is the same value as C1, C2, C3, and C4.

( ) Are for TSSOP package only.

## PIN DESCRIPTIONS

**V<sub>CC</sub>, GND:** DC power is provided to the device on these pins. V<sub>CC</sub> is the +5-volt input.

**V<sub>+</sub>:** Positive supply output (RS-232). V<sub>+</sub> requires an external storage charge capacitor of at least 0.1  $\mu$ F. A larger capacitor (up to 10  $\mu$ F) can be used to reduce supply ripple.

**V<sub>-</sub>:** Negative supply output (RS-232). V<sub>-</sub> requires an external storage capacitor of at least 0.1  $\mu$ F. A larger capacitor (up to 10  $\mu$ F) can be used to reduce supply ripple.

**T<sub>1IN</sub>, T<sub>2IN</sub>:** Standard TTL/CMOS inputs for the RS-232 drivers. The inputs of unused drivers can be left unconnected since each input has a 400 k $\Omega$  pullup resistor.

**T<sub>1OUT</sub>, T<sub>2OUT</sub>:** Driver outputs at RS-232 levels. Driver output swing meets RS-232 levels for loads up to 3 k $\Omega$ . These driver outputs provide current necessary to meet RS-232 levels for loads up to 2500 pF.

**R1<sub>IN</sub>, R2<sub>IN</sub>:** Receiver inputs. These inputs accept RS-232 level signals ( $\pm 25$  volts) into a protected 5 k $\Omega$  terminating resistor. Each receiver provides 0.5V hysteresis (typical) for noise immunity.

**R1<sub>OUT</sub>, R2<sub>OUT</sub>:** Receiver outputs at TTL/CMOS levels.

**C1+, C1-, C2+, C2-:** Charge pump capacitor inputs. These pins require two external capacitors (0.1  $\mu$ F minimum, 10  $\mu$ F maximum and should be the same size as C3 and C4). Capacitor 1 is connected between C1+ and C1-. Capacitor 2 is connected between C2+ and C2-. Capacitor C1 can be omitted if +12 volts is connected directly to V+. Likewise, C2 can be omitted if -12V is connected directly to V-.

## DUAL CHARGE PUMP CONVERTERS

The DS232A has a two-stage on-board charge pump circuit that is used to generate  $\pm 10$  volts from a single +5-volt supply. In the first stage, capacitor C1 doubles the +5V supply to +10 volts which is then stored on capacitor C3. The second stage uses capacitor C2 to invert the +10V potential to -10V. This charge is then stored on capacitor C4. The  $\pm 10$ -volt supplies allow the DS232A to provide the necessary output levels for RS-232 communication. The DS232A will operate with charge pump capacitors as low as 0.1  $\mu$ F. Larger capacitors (up to 10  $\mu$ F) can be used to reduce supply ripple.

## RS-232 DRIVERS

The two RS-232 drivers are powered by the internal  $\pm 10$ -volt supplies generated by the on-board charge pump. The driver inputs are both TTL and CMOS compatible. Each input has an internal 400 k $\Omega$  pullup resistor so that unused transmitter inputs can be left unconnected. The open circuit output voltage swing is from (V+ - 0.6) to V- volts. Worst case conditions for EIA-232E/V.28 of  $\pm 5$ -volt driving a 3 k $\Omega$  load and 2500 pF are met at maximum operating temperature and V<sub>CC</sub> equal to 4.5 volts. Typical voltage swings of  $\pm 8$  volts occur when loaded with a nominal 5 k $\Omega$  RS-232 receiver. As required by EIA-232E and V.28 specifications, the slew rate at the output is limited to less than 30 volts/ $\mu$ s. Typical slew rates are 20 volts/ $\mu$ s unloaded and 12 volts/ $\mu$ s with 3 k $\Omega$  and 2500 pF load. These slew rates allow for bit rates of over 250k bits/s. Driver outputs maintain high impedance when power is off.

## RS-232 RECEIVERS

The two receivers conform fully to the RS-232E specifications. The input impedance is typically 5 k $\Omega$  and can withstand up to  $\pm 25$  volts with or without V<sub>CC</sub> applied. The input switching thresholds are within the  $\pm 3$ -volt limit of RS-232E specification with an input threshold low of 0.8 volts and an input threshold high of 2.4 volts. The receivers have 0.5 volts of hysteresis (typical) to improve noise rejection. The TTL/CMOS compatible outputs of the receivers will be low whenever the RS-232 input is greater than 2.4 volts. The receiver output will be high when the input is floating or driven between +0.8 volts and -25 volts.

**ABSOLUTE MAXIMUM RATINGS\***

## Absolute Maximum Ratings

$V_{CC}$	-0.3V to +7.0V
$V_{+}$	$(V_{CC}-0.3V)$ to +14V
$V_{-}$	+0.3V to -14V

## Input Voltages

$T_{IN}$	-0.3V to $(V_{CC}+0.3V)$
$R_{IN}$	$\pm 30V$

## Output Voltages

$T_{OUT}$	$(V_{+} + 0.3V)$ to $(V_{-} - 0.3V)$
$R_{OUT}$	-0.3V to $(V_{CC} + 0.3V)$
Short Circuit Duration, $T_{OUT}$	Continuous

\* This is a stress rating only and functional operation of the device at these or any other conditions above those indicated in the operation sections of this specification is not implied. Exposure to absolute maximum rating conditions for extended periods of time may affect reliability.

**RECOMMENDED DC OPERATING CONDITIONS** (0°C to 70°C)

PARAMETER	SYMBOL	MIN	TYP	MAX	UNITS	NOTES
Operating Supply Voltage	$V_{CC}$	4.5		5.5	V	1

**DC ELECTRICAL CHARACTERISTICS** (0°C to 70°C)

PARAMETER	SYMBOL	MIN	TYP	MAX	UNITS	NOTES
Power Supply Current (No Load)	$I_{CC1}$		4	10	mA	
Power Supply Current (3 k $\Omega$ Load All Outputs)	$I_{CC2}$		15		mA	
<b>RS-232 Transmitters</b>						
Output Voltage Swing	$V_{ORS}$	$\pm 5$	$\pm 8$		V	2
Input Logic Threshold Low	$V_{TTL}$	0.8	1.4		V	
Input Logic Threshold High	$V_{TTH}$		1.4	2.0	V	
Maximum Data Rate	$f_D$	250	350		k bits/s	
Logic Pullup/Input Current	$I_{PU}$		5	40	$\mu A$	
Transmitter Output Resistance	$R_{OUT}$	300	10M		$\Omega$	3
Output Short-Circuit Current	$I_{TSC}$	$\pm 15$	$\pm 30$	$\pm 100$	mA	4

**DC ELECTRICAL CHARACTERISTICS** (continued) (0°C to 70°C)

<b>RS-232 Receivers</b>						
RS-232 Input Voltage Operating Range	$V_{IR}$	$\pm 25$	$\pm 30$		V	
RS-232 Input Threshold Low	$V_{RTL}$	0.8	1.3		V	
RS-232 Input Threshold High	$V_{RTH}$		1.8	2.4	V	
RS-232 Input Hysteresis	$V_{HY}$	0.2	0.5	1	V	
RS-232 Input Resistance	$R_{IN}$	3	5	7	k $\Omega$	
TTL/CMOS Output Voltage Low	$V_{ROL}$		0.2	0.4	V	5
TTL/CMOS Output Voltage High	$V_{ROH}$	3.5	$V_{CC}-0.2$		V	6
TTL/CMOS Output Short Circuit Current ( $V_{OUT}=GND$ )	$I_{RSC}$	-2	-10		mA	
TTL/CMOS Output Short Circuit Current ( $V_{OUT}=V_{CC}$ )	$I_{RSC}$	10	30		mA	

**AC ELECTRICAL CHARACTERISTICS** (0°C to 70°C)

PARAMETER	SYMBOL	MIN	TYP	MAX	UNITS	NOTES
Transition Slew Rate	$t_{SR}$	6	12	30	V/ $\mu$ s	7
Transmitter Propagation Delay TTL to RS-232	$t_{PHLT}$ $t_{PLHT}$		1.3 1.5	3.5 3.5	$\mu$ s $\mu$ s	
Receiver Propagation Delay RS-232 to TTL	$t_{PHLR}$ $t_{PLHR}$		0.5 0.6	1 1	$\mu$ s $\mu$ s	
Transmitter + to - Propagation Delay Difference	$t_{PHLT}$ $-t_{PLHT}$		300		ns	
Receiver + to - Propagation Delay Difference	$t_{PHLR}$ $-t_{PLHR}$		100		ns	

**NOTES:**

- All voltages are referenced to ground.
- All transmitter outputs loaded with 3 k $\Omega$  to ground
- $V_{CC} = V_{+} = V_{-} = 0V$ ;  $V_{OUT} = \pm 2V$ .
- $V_{OUT} = 0V$ .
- $I_{OUT} = 3.2$  mA.
- $I_{OUT} = -1.0$  mA.
- $C_L = 50$  pF - 2500 pF;  $R_L = 3$  k $\Omega$  - 7 k $\Omega$ ;  $V_{CC} = 5V$ ;  $T_A = 25^{\circ}C$ .

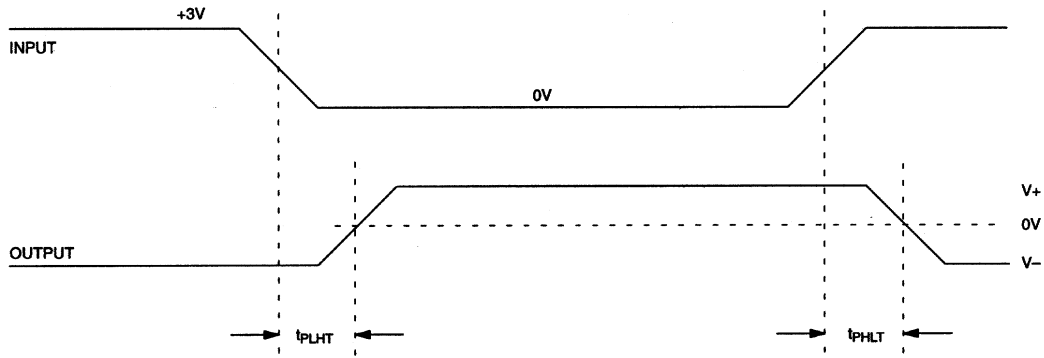
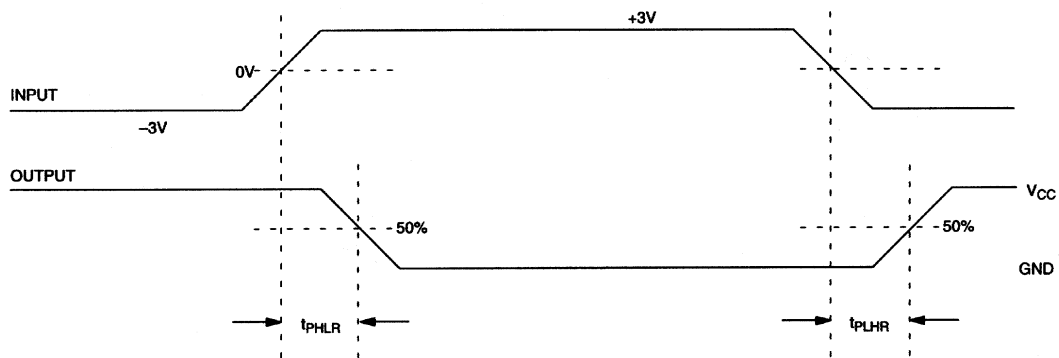
**TRANSMITTER PROPAGATION DELAY TIMING Figure 2****RECEIVER PROPAGATION DELAY TIMING Figure 3**

# 16-PIN DIP (300-MIL)

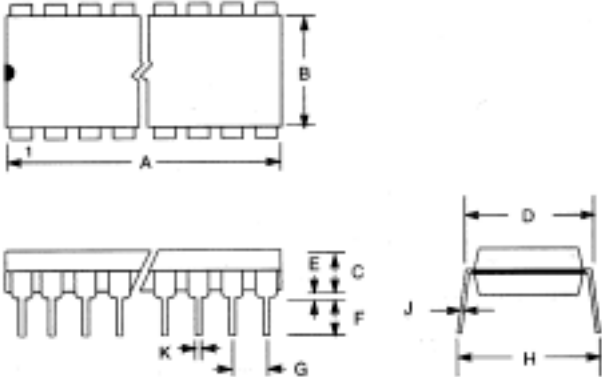

PKG	16-PIN	
	DIM	MIN
A IN.	0.740	0.780
MM	18.80	19.81
B IN.	0.240	0.260
MM	6.10	6.60
C IN.	0.120	0.140
MM	3.05	3.56
D IN.	0.300	0.325
MM	7.62	8.26
E IN.	0.015	0.040
MM	0.38	1.02
F IN.	0.120	0.140
MM	3.04	3.56
G IN.	0.090	0.110
MM	2.29	2.79
H IN.	0.320	0.370
MM	8.13	9.40
J IN.	0.008	0.012
MM	0.20	0.30
K IN.	0.015	0.021
MM	0.38	0.53

16-PIN SOIC (150-MIL)

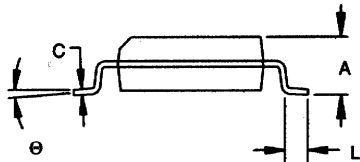
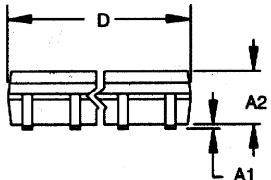
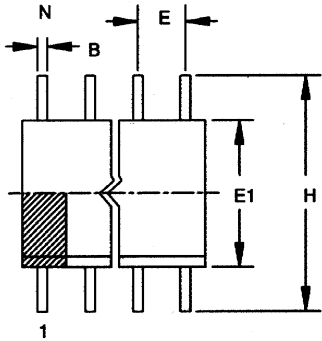

PKG	16-PIN	
DIM	MIN	MAX
A IN.	0.053	0.069
MM	1.35	1.75
A1 IN.	0.004	0.010
MM	0.10	0.25
A2 IN.	0.048	0.062
MM	1.24	1.57
B IN.	0.012	0.020
MM	0.30	0.50
C IN.	0.007	0.011
MM	0.17	0.28
D IN.	0.386	0.393
MM	9.80	9.98
E IN.	0.050 BSC	
MM	1.27 BSC	
E1 IN.	0.150	0.158
MM	3.81	4.01
H IN.	0.230	0.244
MM	5.84	6.20
L IN.	0.016	0.050
MM	0.40	0.89
θ	0°	8°



16-PIN SOIC (300-MIL)

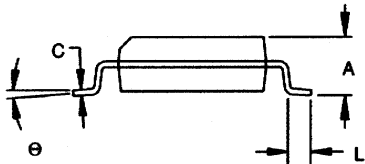
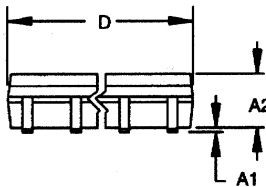
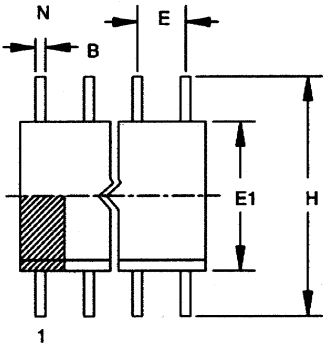

PKG	16-PIN	
DIM	MIN	MAX
A IN. MM	0.094 2.39	0.105 2.67
A1 IN. MM	0.004 0.102	0.012 0.30
A2 IN. MM	0.089 2.26	0.095 2.41
b IN. MM	0.013 0.33	0.020 0.51
C IN. MM	0.009 0.229	0.013 0.33
D IN. MM	0.398 10.11	0.412 10.46
E IN. MM	0.050 BSC 1.27 BSC	
E1 IN. MM	0.290 7.37	0.300 7.62
H IN. MM	0.398 10.11	0.416 10.57
L IN. MM	0.016 0.40	0.040 1.02
θ	0°	8°

# 20-PIN TSSOP

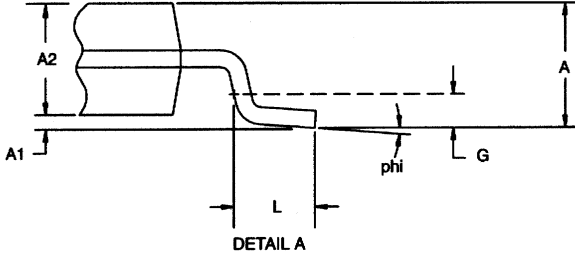
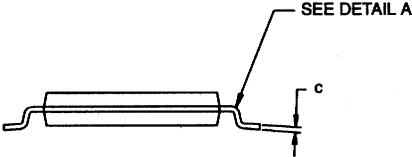
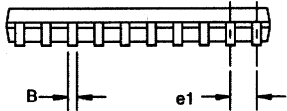
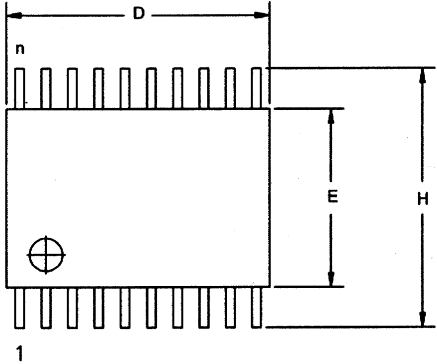

DIM	MIN	MAX
A MM	-	1.10
A1 MM	0.05	-
A2 MM	0.75	1.05
C MM	0.09	0.18
L MM	0.50	0.70
e1 MM	0.65 BSC	
B MM	0.18	0.30
D MM	6.40	6.90
E MM	4.40 NOM	
G MM	0.25 REF	
H MM	6.25	6.55
phi	0°	8°